

# axxera™

CD Receiver

Made for  
iPod iPhone



## Installation & Owner's Manual

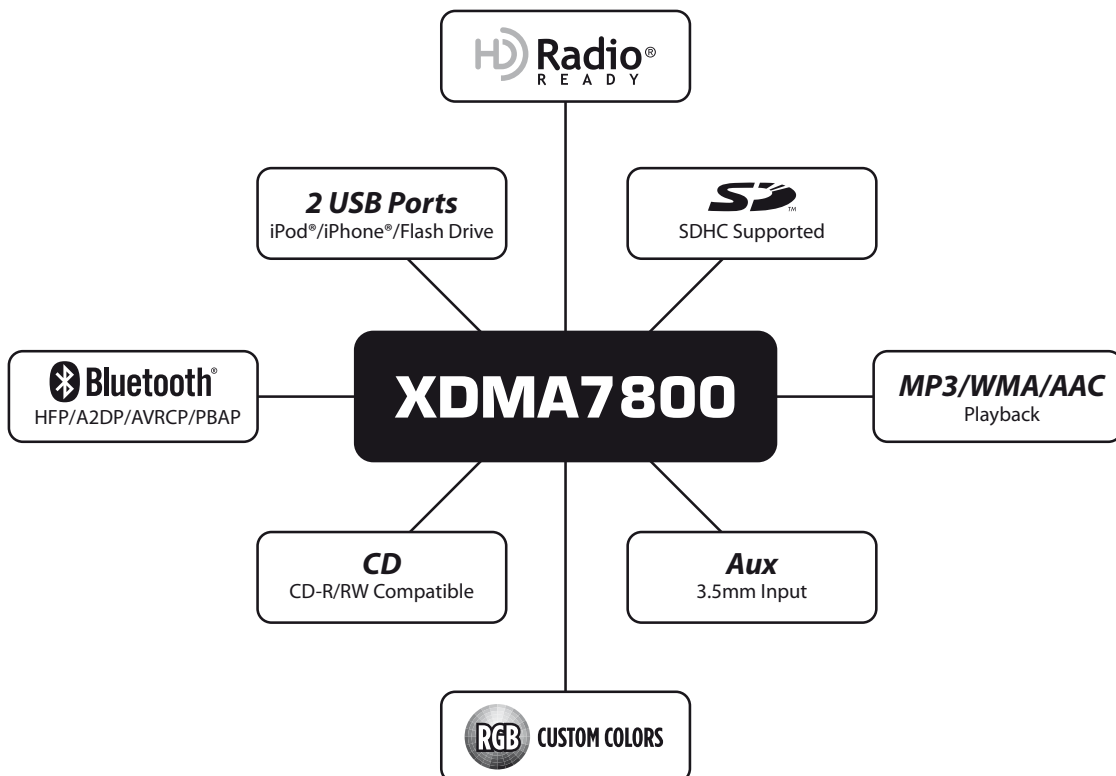

# XDMA7800

## Preparation

Please read entire manual before installation.

### Before You Start

- Disconnect negative battery terminal. Consult a qualified technician for instructions.
- Avoid installing the unit where it would be subject to high temperatures, such as from direct sunlight, or where it would be subject to dust, dirt or excessive vibration.

### Getting Started

- Remove trim ring from unit,
- Insert the supplied keys into the slots as shown, and slide the unit out of the mounting sleeve.
- Install mounting sleeve into opening, bending tabs to secure.
- Connect wiring harness and antenna. Consult a qualified technician if you are unsure.
- Certain vehicles may require an installation kit and/or wiring harness adapter (sold separately).
- Test for correct operation and slide the unit into mounting sleeve to secure.
- Snap trim ring into place.

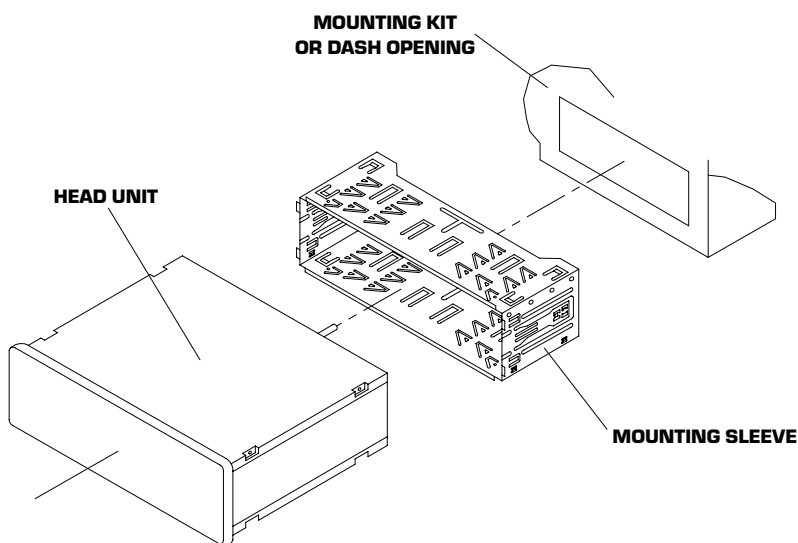
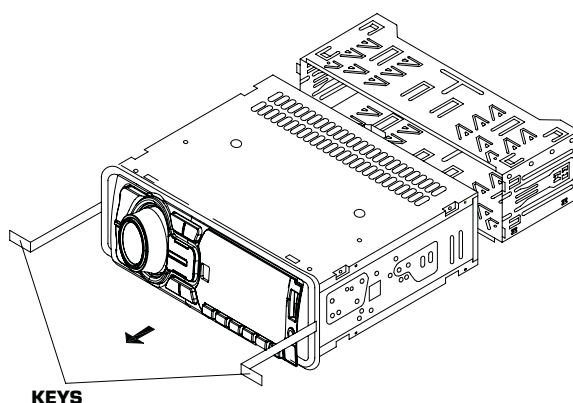

### TYPICAL FRONT-LOAD DIN MOUNTING METHOD

# XDMA7800

## Wiring Diagram

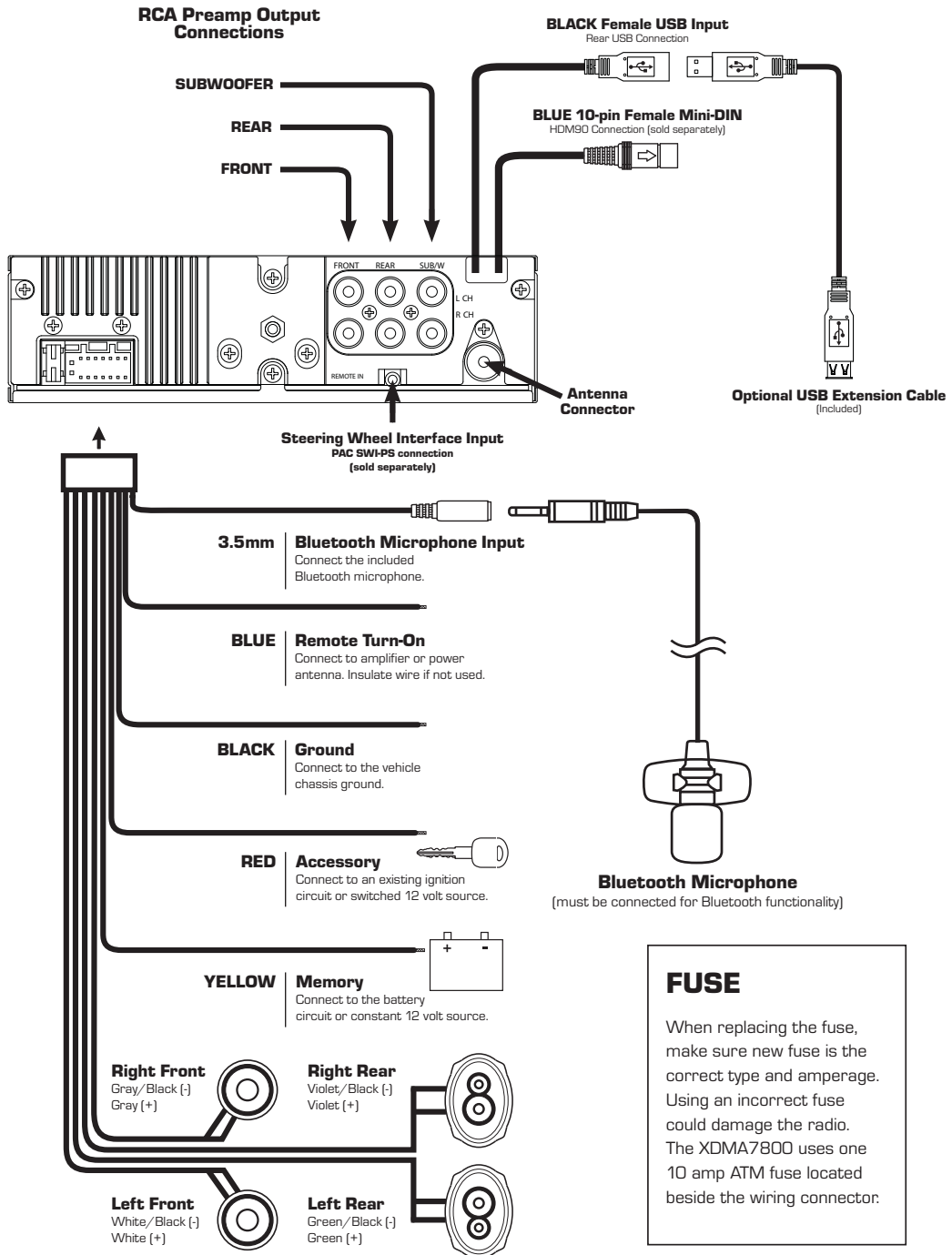

# XDMA7800

## Receiver - Controls

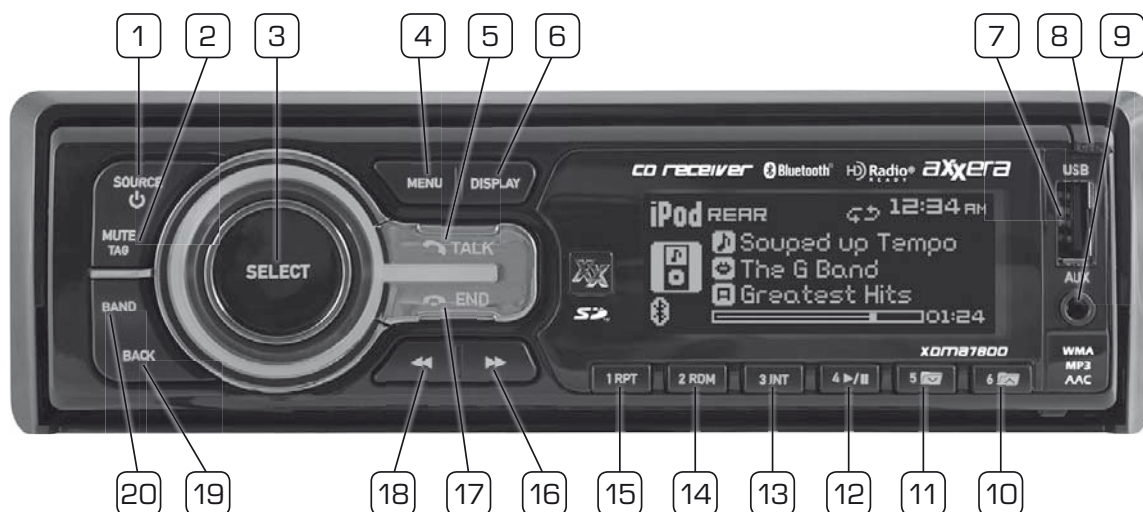

Control	Function	Description
<b>1</b>	Source/Power	Changes to another mode of operation. Hold down to power off/on.
<b>2</b>	Mute/Tag	Mutes the audio output. Activates iTunes Tagging (HDM90 required).
<b>3</b>	Select	Activates music searches. Confirms menu options.
<b>4</b>	Menu	Accesses configuration options within the main menu.
<b>5</b>	Bluetooth Talk	Answers phone calls. Accesses Number Dial, Recent Calls and Redial functions.
<b>6</b>	Display	Cycles displayed information. Hold to set the clock.
<b>7</b>	Front USB Port	Connect a USB flash drive, iPod or iPhone device.
<b>8</b>	Open	Opens the front panel to access the reset button, CD and SD card slots.
<b>9</b>	Auxiliary Input	Connect a 3.5mm cable from the headphone output of an MP3 player.
<b>10</b>	Preset 6/Folder Up	Recall/Set preset 6. Changes to the next folder.
<b>11</b>	Preset 5/Folder Down	Recall/Set preset 5. Changes to the previous folder.
<b>12</b>	Preset 4/Play/Pause	Recall/Set preset 4. Cycle between pause/play.
<b>13</b>	Preset 3/Intro	Recall/Set preset 3. Intro menu (plays the first 10 seconds of each song).
<b>14</b>	Preset 2/Random	Recall/Set preset 2. Random menu (shuffles songs in a random playback order).
<b>15</b>	Preset 1/Repeat	Recall/Set preset 1. Repeat menu (repeat the current song, folder or album).
<b>16</b>	Track/Tune Up	Changes to the next song or radio station. Hold to fast forward or seek up.
<b>17</b>	Bluetooth End Call	Ends the current phone call. Hold to disconnect from Bluetooth.
<b>18</b>	Track/Tune Down	Changes to the previous song or radio station. Hold to rewind or seek down.
<b>19</b>	Back	Steps backward or exits music searches or menus.
<b>20</b>	Band	Accesses additional radio presets and cycles between FM and AM radio.

# XDMA7800

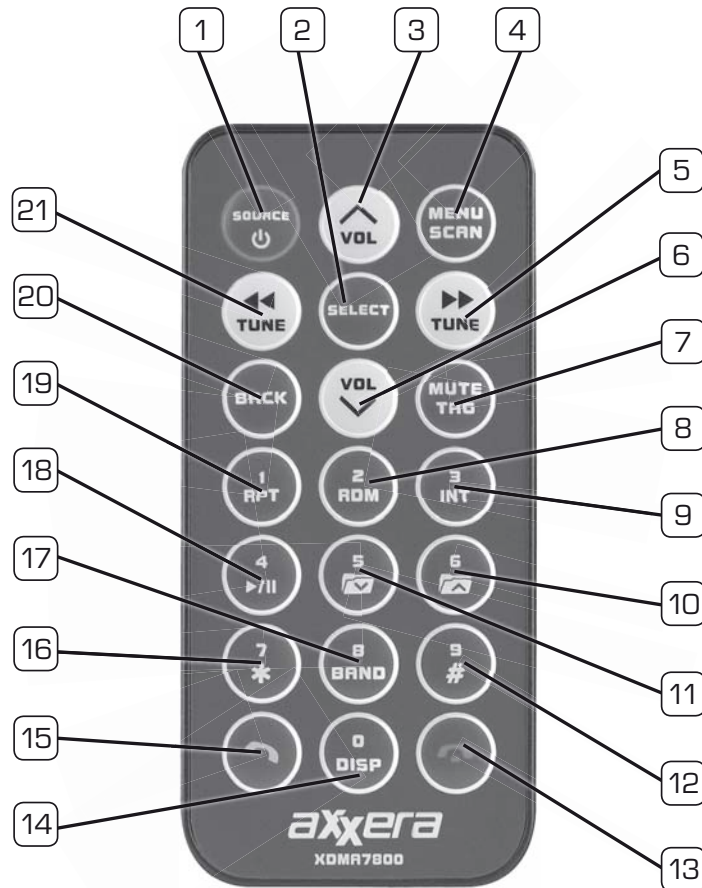

## IR Remote - Controls



- |    |                        |    |                         |
|----|------------------------|----|-------------------------|
| 1  | Source / Power (⏻)     | 12 | Key 9 / # Key           |
| 2  | Select                 | 13 | End Call                |
| 3  | Volume Up              | 14 | Key 0 / Display         |
| 4  | Menu                   | 15 | Talk                    |
| 5  | Tune / Track Up        | 16 | Key 7 / * Key           |
| 6  | Volume Down            | 17 | Key 8 / Band            |
| 7  | Mute / Tag             | 18 | Preset 4 / Play / Pause |
| 8  | Preset 2 / Random      | 19 | Preset 1 / Repeat       |
| 9  | Preset 3 / Intro       | 20 | Back                    |
| 10 | Preset 6 / Folder Up   | 21 | Tune / Track Down       |
| 11 | Preset 5 / Folder Down |    |                         |

# XDMA7800

## General Operation

<b>Faceplate Removal</b>	Press <b>RELEASE</b> to fold down the front panel. While pushing the front panel left, pull the right side away to remove. To reinstall, slide in bottom left side, then snap left side up and into place.
<b>Power On/Off</b>	Press  or any other button to turn unit on. Press and hold  to turn unit off.
<b>Source</b>	<p>Press <b>SOURCE</b> to select between AM/FM, CD, auxiliary input, operation of iPod, USB, SD and Bluetooth modes. Modes of operation are indicated in the display.</p> <p><b>Note:</b> CD mode will not appear unless a CD is inserted. Operation of iPod mode will not appear unless an iPod device has been connected. USB and SD modes will not appear unless a USB device has been connected or SD card has been inserted.</p> <p><b>Note:</b> HD Radio mode will replace AM/FM mode when the HDM90 is connected.</p> <p><b>Note:</b> iPod and iPhone devices may be connected to the front and/or rear USB ports.</p>
<b>Steering Wheel Interface Input</b>	<p>The steering wheel interface input located on the back of the head unit allows connection to the <b>PAC (Pacific Accessory Corporation) SWI-PS</b> interface module (sold separately). Visit <a href="http://www.pac-audio.com">www.pac-audio.com</a> for details.</p> <p>To configure steering wheel controls, follow the instructions provided with the <b>PAC SWI-PS</b> interface module. After installing the interface module, insert the module's 3.5mm jack into the port on the back of the head unit.</p>
<b>Auxiliary Input</b>	Insert 3.5 mm plug to connect your portable audio device.
<b>Volume</b>	Adjust volume using volume knob (00-46).
<b>Mute</b>	Press <b>MUTE</b> to silence the audio. Press <b>MUTE</b> again to cancel.
<b>Reset</b>	Press the <b>RESET</b> button, located behind the front panel, to reset the unit back to the factory settings if abnormal operation occurs.
<b>Display</b>	Press <b>DISPLAY</b> to toggle between items such as clock, radio frequency, or ID3 tag song information.
<b>Set the Clock</b>	With the unit on, press and hold <b>DISPLAY</b> until the clock begins to flash, then release. Press <b>TUNE</b> ◀◀ to adjust the hours and <b>TUNE</b> ▶▶ to adjust the minutes. Press <b>DISP</b> momentarily to save the selected time.
<b>12/24-Hour Clock</b>	<p>The clock will display 12-hour AM/PM time in USA frequency spacing mode (PM 10:00). In European frequency spacing mode, the clock will display 24-hour time (22:00).</p> <p><b>Note:</b> 24-hour time and European frequency spacing are not available if the HDM90 HD Radio™ tuner are connected.</p>

# XDMA7800

## Setup Menu

Press **MENU** to access the setup menu, then turn the volume knob to cycle through menu categories: **Audio, Color, Display, Tuner, iPod, Bluetooth and General**.

- When desired category appears in the display, press **SELECT**, then rotate the **volume knob** left/right to cycle through the options in each category.
- When desired option appears in the display, press **SELECT**, then rotate the **volume knob** left/right to adjust or activate desired function.
- Press **BACK** to return to the previous menu, or exit the menu while the main menu is displayed.

### Audio Menu

Press **MENU**, then press **SELECT** when Audio is highlighted to enter the Audio Menu. Rotate the **volume knob** to cycle through the following options.

Function	Options	Action
<b>Bass</b>	Level	Adjust the frequency bass output from -6 to +6.
	Quality Factor	Adjust the bass quality factor: 0.7, 1.0, 1.4, 2.0. • Narrows/expands the bandwidth around the bass center frequency.
	Center Frequency	Adjust the bass center frequency: 50Hz, 100Hz, 200Hz. • Focuses the bass level adjustments around a specific frequency.
<b>Middle</b>	Level	Adjust the mid frequency output from -6 to +6.
	Quality Factor	Adjust the mid quality factor: 0.7, 1.0, 1.4, 2.0. • Narrows/expands the bandwidth around the mid center frequency.
	Center Frequency	Adjust the mid center frequency: 0.5kHz, 1.0kHz, 2.0kHz. • Focuses the mid level adjustments around a specific frequency.
<b>Treble</b>	Level	Adjust the treble frequency output from -6 to +6.
	Quality Factor	Adjust the mid quality factor: 0.7, 1.0, 1.4, 2.0. • Narrows/expands the bandwidth around the treble center frequency.
	Center Frequency	Adjust the treble center frequency: 5kHz, 10kHz, 15kHz. • Focuses the treble level adjustments around a specific frequency.
<b>Balance</b>	Left - Right	Shift the speaker output from the left (-12) to the right (+12).
<b>Fader</b>	Front - Rear	Shift the speaker output from the front (-12) to the rear (+12).
<b>Equalizer</b>	Preset EQs	Select between Flat, Pop, Jazz, Classic, Beat, Rock, User. • Any Bass, Mid or Treble adjustments are saved as the "User" EQ.
<b>Subwoofer</b>	Level	Adjust the level of the subwoofer output from 0 (off) to +12.
	Frequency	Set the cut off frequency for the low pass filter: Full, 55Hz, 85Hz, 120Hz. • Filters out mid/treble frequencies from the subwoofer output.
	Phase	Reverses the polarity to accommodate forward/rear firing mounting options.
<b>High Pass Filters</b>	Off 62/95/135	Set the cut off frequency for the high pass filter: Off, 62Hz, 95Hz, 135Hz. • Filters out bass frequencies from the front/rear speaker outputs. • Selecting Off allow the full range of frequencies to the speakers.
<b>Source Level</b>	-6 to +6	Adjusts the output level for each mode individually from -6 to +6.
<b>Loudness</b>	Off/1/2/3	Set the loud setting: Off, Loud 1, Loud 2, Loud 3. • Enhances the bass and treble frequencies at low volumes.

# XDMA7800

## Setup Menu

### Color Menu

Menu Function	Options
<b>Auto Change</b>	Sets the unit to rotate between all illumination colors automatically. Setting a preset or user color will cancel the automatic color change.
<b>Set Color</b>	Adjust the color of the button and LCD illumination between 31 preset colors. <ul style="list-style-type: none"> <li>• <b>Off</b>: sets the color to white. <b>(default)</b></li> <li>• <b>Day/Night</b>: sets the color to change to different colors during the day or night. The day and night colors must be set in the Day/Night color menu below.</li> <li>• <b>User</b>: sets the color to the custom color. The custom color must be set in the menu below.</li> <li>• <b>1-31</b>: choose from any of the 31 preset colors.</li> </ul>
<b>Set Custom Color</b>	Individually select the level of Red, Green and Blue from 0 - 16. Any combination of these colors can be selected. <b>Important Note:</b> Setting each Red, Green and Blue levels to 1 will turn off set turn off the illumination for the LCD and buttons. If this color is set, pressing <b>RESET</b> may be required.
<b>Set Day/Night Color</b>	Sets individual colors for the day or night. (The clock must be set for proper function). <ul style="list-style-type: none"> <li>• <b>Day Color</b>: sets the daytime color to a preset or custom color.</li> <li>• <b>Night Color</b>: sets the nighttime color to a preset or custom color.</li> <li>• <b>Time</b>: adjusts the night time span. Turn the volume knob to adjust. (default is 7pm to 7am).</li> </ul>

### Display Menu

Menu Function	Options
<b>Scrolling</b>	Changes the scrolling style used for displayed information on the LCD between: <ul style="list-style-type: none"> <li>• <b>Off</b>: no scrolling.</li> <li>• <b>Once</b>: only scroll one time. <b>(default)</b></li> <li>• <b>15 seconds</b>: scroll once per 15 seconds.</li> <li>• <b>On</b>: constantly scrolling.</li> </ul>
<b>Dimmer</b>	Adjusts the illumination level for the buttons and LCD between: <ul style="list-style-type: none"> <li>• <b>High</b>: brightest illumination level. <b>(default)</b></li> <li>• <b>Medium</b>: middle illumination level.</li> <li>• <b>Low</b>: dimmest illumination level.</li> </ul>
<b>LCD Type</b>	Sets the LCD illumination type <ul style="list-style-type: none"> <li>• <b>Positive</b>: Color background with black text.</li> <li>• <b>Negative</b>: Black background with color text.</li> <li>• <b>Automatic</b>: Switches to positive during the daytime, and negative during the night. <b>(default)</b></li> </ul>

### Tuner Menu

Menu Function	Options
<b>Auto Station Store</b>	Press <b>SELECT</b> to begin storing strong radio stations to the 1 - 6 preset buttons in the current band.
<b>Local</b>	Allow only strong radio stations to be received, blocking stations with weak signal.
<b>Frequency Sp.</b>	Changes the tuner to receive USA <b>(default)</b> or European radio frequencies.
<b>Tune/Seek Priority</b>	Switches the function of the seek/tune up and down buttons: <ul style="list-style-type: none"> <li>• <b>Seek</b>: Quick press will seek to the next strong channel. Press and hold to activate manual tuning.</li> <li>• <b>Tune</b>: Quick press will manually tune to the next station. Press and hold to seek to the next strong channel. <b>(default)</b></li> </ul>



# XDMA7800

## Setup Menu

### HD Radio™ Tuner Menu

When the optional HDM90 HD Radio tuner (sold separately) is connected, the following additional menu options will appear in the Tuner menu.

Menu Function	Options
<b>HD Seek</b>	Limits the seek and auto station store functions to only access HD Radio channels. <ul style="list-style-type: none"><li>• <b>On:</b> Seek and Auto Station Store will only access digital HD Radio channels.</li><li>• <b>Off:</b> All analog and digital channels will be accessed. <b>(default)</b></li></ul>
<b>Delete Tags</b>	Press <b>SELECT</b> to erase all Tags that are saved in memory. (Does not affect Tags that have been transferred to an iPod device.)
<b>Tuner Mode</b>	Enables/disables the digital HD Radio channel reception. <ul style="list-style-type: none"><li>• <b>Analog:</b> Limits the reception to standard analog channels only.</li><li>• <b>Digital:</b> Allows both digital and analog channels to be received. <b>(default)</b></li></ul>

### iPod Menu

Menu Function	Options
<b>iPod Control</b>	Switches the control between the head unit and the iPod/iPhone device. <ul style="list-style-type: none"><li>• <b>Full:</b> Enables total control of the iPod device from the XDMA7800. <b>(default)</b></li><li>• <b>Manual:</b> Releases the control of the iPod device. Music searches and track selections must be done from the device. The iPod device will continue to charge.</li></ul>

### Bluetooth™ Menu

Menu Function	Options
<b>Bluetooth</b>	Enables/disables Bluetooth functionality.
<b>Auto Answer</b>	Answers all incoming calls automatically without requiring a button press. <ul style="list-style-type: none"><li>• <b>On:</b> Automatically accepts all incoming calls after 2-3 rings without pressing the <b>TALK</b> button.</li><li>• <b>Off:</b> Incoming calls can be accepted by pressing the TALK button, or refused by pressing the END button. <b>(default)</b></li></ul>
<b>Auto Connect</b>	Connects the most recently paired Bluetooth device automatically. <ul style="list-style-type: none"><li>• <b>On:</b> Connects automatically when the XDMA7800 is powered on and the Bluetooth device is in range. <b>(default)</b></li><li>• <b>Off:</b> Will not connect to any Bluetooth device unless you manually select the device from the "paired devices" menu.</li></ul>
<b>Speaker Output</b>	Directs the Bluetooth audio to only the front speakers <b>(default)</b> or to all four speakers.

# XDMA7800

## Setup Menu

### General Menu

Menu Function	Options
<b>Clock</b>	Enables/disables the clock to be displayed on the LCD when the XDMA7800 is powered off using the power button.
<b>Auxiliary</b>	Enables/disables the 3.5mm auxiliary input on the front panel. <ul style="list-style-type: none"><li>• <b>On</b>: The auxiliary input is enabled. <b>(default)</b></li><li>• <b>Off</b>: Auxiliary input mode is removed from the list of available modes.</li></ul>
<b>Beep</b>	When enabled, every button press will output a beep tone. <ul style="list-style-type: none"><li>• <b>On</b>: Every button press will output a single beep tone.</li><li>• <b>Off</b>: Only press-and-hold button functions will output a double beep tone. <b>(default)</b></li></ul>
<b>Prog. Volume</b>	Sets the XDMA7800 to power-on to the same volume level every time. <ul style="list-style-type: none"><li>• <b>Off</b>: The unit will turn on at the last volume level that was set. <b>(default)</b></li><li>• <b>1-30</b>: Choosing a volume level will program the unit to always turn on at that volume.</li></ul>
<b>Power-on Message</b>	Allows the "Good Morning/Afternoon/Evening" message that may be shown when the unit is powered on.
<b>Demo mode</b>	Enables/disables the demonstration mode for display purposes.
<b>Set Clock</b>	Adjusts the time for the internal clock. <ul style="list-style-type: none"><li>• Press ◀◀ to adjust the hours.</li><li>• Press ▶▶ to adjust the minutes.</li></ul>

## AM/FM Tuner Operation

<b>Seek Tuning</b>	Press <b>TUNE</b> ◀◀ or <b>TUNE</b> ▶▶ for more than one second to seek the next strong station.
<b>Manual Tuning</b>	Press <b>TUNE</b> ◀◀ or <b>TUNE</b> ▶▶ momentarily to move radio frequency up or down one step at a time. Press and hold to advance quickly.
<b>Scan Tuning</b>	Press <b>SCAN</b> on the remote control momentarily to preview strong stations on the current band, pausing for five seconds at each. Press <b>SCAN</b> on the remote control again to cancel.
<b>Band</b>	Press <b>BAND</b> to select between FM1, FM2, FM3, AM1 and AM2 bands. Up to six presets can be programmed for each band.
<b>Storing and Recalling Station Presets</b>	Up to 18 FM stations and 12 AM stations can be stored in memory. To store a station, select the desired band and station. Press and hold the desired preset button (1-6) for more than two seconds. When stored, the preset number will appear in the display. The station can be recalled by pressing the corresponding preset button.

## XDMA7800

# HD Radio™ Tuner Operation (HDM90)

### Connecting the HDM90 (sold separately)

HD Radio operation requires connecting the HDM90 HD Radio tuner (sold separately). Refer to the HDM90 instructions for connection details.

### Display

When the unit is tuned to an HD Radio station, press DISP to toggle the display between the artist/title and program type/station name.

### HD Radio Tuning

Refer to the instructions for seek, manual and scan tuning on page 10.

When HD Radio station is selected, an HD Radio logo will begin to flash on the display. After about five seconds, HD or HD1 will illuminate after the radio frequency.

- If "HD" appears, the radio station is broadcasting a higher quality sound. No additional stations are available.
- If "HD1" appears, additional multicast channels (HD2 and/or HD3) are available. Press **TUNE ►►** to tune to other available multicast channels.

### Auto Station Store

While in HD SEEK mode, the AUTO STORE menu option will automatically store only HD Radio stations, beginning from the lowest frequency.

**Note:** Multicast channels (HD2 and/or HD3) are not automatically stored with the Auto Station Store feature but can be stored by holding the desired preset number (1-6) for 3 seconds.

### Setting HD Radio Presets

HD Radio multicast stations (HD2 and HD3) can be stored as presets in the same way as analog radio stations. Press and hold a preset button until it beeps to store the preset.

### Recalling an HD Radio Multicast Preset

When selecting a preset multicast station, "LINKING" will appear in the display for approximately 5 seconds while the multicast station information is received.

**Note:** If the HD Radio signal on the preset is unavailable, the unit reverts to the previous analog or digital station.

### HD Seek

See page 9 for the details on the HD Seek function.

## XDMA7800

# iTunes® Tagging Operation (HDM90)

**Overview** The iTunes Tagging feature of the XDMA7800 requires the optional HDM90 module (sold separately). Once connected, the HDM90 allows the user to "Tag" songs that are playing on HD Radio™ stations and enables them to be purchased later through iTunes. With the touch of a button the unit will remember the title and artist song information, and then transfer that information to your iPod the next time you connect it to the XDMA7800. A new list called "Tagged" will appear in iTunes, giving you the option to purchase each song.

### Tagging Music Step 1

**Tune to an HD Radio station.** The HD logo will illuminate along with a TAG icon - indicating that a digital station is tuned and the tag is available.

### Step 2

**Press and hold the MUTE/TAG button.** The Tag information will be saved to internal memory. After tagging is completed, a confirmation will be displayed. The song information will be saved in memory until an iPod device is plugged in. Up to 64 Tags can be saved before they must be transferred or deleted.

### Step 3

**Plug in an iPod device.** All the Tags currently in memory will be automatically transferred, deleting the Tags from the head unit's memory. See page 19 for connection details.

If an iPod device is plugged in when a song is tagged, the Tag will be immediately transferred to the iPod device (see page 13 for compatibility with iPod devices).

After the Tag transfer to the iPod device is complete, the XDMA7800 will display the number of tags that were successfully transferred.

### Step 4

**Sync with iTunes.** A list named "Tagged" will appear on the left in the iTunes software. Click on the "Tagged" list to view all the songs that have been tagged and click the "view" button for purchase information.

**Note:** Some iPod devices may require you to select 'transfer purchases' in the context menu from the name of your iPod device to transfer Tags to iTunes.

## Managing Tags

### Deleting All Tags

See page 9 for details on deleting the tags that are currently saved in the XDMA7800's memory.

**Note:** After transferring Tags, they are managed from the iTunes software.

## XDMA7800

# iTunes® Tagging Operation (HDM90)

## Troubleshooting

Displayed Message	Description
<b>CHECK iPod VER</b>	There is a compatibility issue with the iPod device that is connected. Check the list of compatible iPod devices below. If the attached iPod device is compatible, update the firmware to the latest version using iTunes.
<b>SENDING TAGS</b>	Tags are being sent to the iPod device. This process can take several minutes depending on the number of Tags being sent.
<b>iPod FULL</b>	There is not enough space on the connected iPod device to transfer the iTunes Tags. Free up space using iTunes.
<b>TRANSFER FAILED</b>	Connection error. Ensure the iPod device is powered on and reconnect the iPod device until a TAGS SENT confirmation is displayed.
<b>ALREADY TAGGED</b>	The same song has already been tagged from the same radio station, and is currently saved in memory. The same song cannot be tagged twice - unless the song is tagged on a different radio station, the Tags are sent to an iPod device or the tags are erased.
<b>MEMORY FULL CONNECT iPod</b>	The internal memory of the HDM90 will hold 64 Tags. An iPod device must be connected to transfer the Tags, or the Tags must be deleted before more songs can be tagged.
<b>NO TAG INFO</b>	There is not sufficient information (artist or title) to tag the song. Some HD Radio™ stations or certain songs may not fully support iTunes Tagging.
<b>TAGGING FAILED</b>	There was an error saving the Tag information to the internal memory. Press and hold the <b>MUTE/TAG</b> button again.
<b>NO TAGS STORED</b>	There are no tags saved in the internal memory. The DELETE TAGS function can only delete Tags that are saved in the internal memory.

### **iPod Device Compatibility with iTunes Tagging**

Compatible with

- \*iPhone 4
- \*iPhone 3GS
- \*iPhone 3G
- \*iPhone
- iPod nano (6th generation)
- iPod nano (5th generation)
- iPod touch (4th generation)
- iPod touch (3rd generation)
- \*iPod touch (2nd generation)
- iPod nano (4th generation)
- iPod classic
- \*iPod touch (1st generation)
- iPod nano (3rd generation)

\*Some iPod devices may require you to select 'transfer purchases' in the context menu from the name of your iPod device to transfer Tags to iTunes.

Go to [www.apple.com/itunes](http://www.apple.com/itunes) for the latest version of the iTunes software.

# XDMA7800

## CD Player Operation

<b>Insert CD</b>	Fold down front panel to access the CD slot. With the label facing up, insert a standard size CD into the CD slot. The CD will automatically begin playback.
<b>Eject CD</b>	Fold down front panel and press <b>EJECT</b> to eject the CD. The unit will change to previous mode of operation. If the disc is not removed within 10 seconds, the unit will reload the disc. The unit does not have to be turned on to eject CD.
<b>Track Select</b>	Press <b>TRACK ►►</b> to skip to the beginning of the next track. Press <b>TRACK ◄◄</b> to return to the beginning of the current track. Pressing <b>TRACK ◄◄</b> again skips to the beginning of the previous track.
<b>Fast Forward/Reverse</b>	Press and hold <b>TRACK ►►</b> or <b>TRACK ◄◄</b> to fast forward or reverse a track.
<b>Pause</b>	Press <b>►/  </b> to temporarily stop CD playback. Press <b>►/  </b> again to resume playback.
<b>Intro</b>	Press <b>INT</b> to enter the Intro menu, then turn the volume knob to select one of the following options: <ul style="list-style-type: none"><li>• OFF - Cancels the <b>INT</b> function.</li><li>• ALL SONGS - Plays the first 10 seconds of each track.</li></ul>
<b>Repeat</b>	Press <b>RPT</b> to enter the Repeat menu, then turn the volume knob to select one of the following options: <ul style="list-style-type: none"><li>• ALL SONGS - Plays all tracks on CD.</li><li>• CURRENT SONG - Continuously repeats selected track.</li></ul>
<b>Random</b>	Press <b>RDM</b> to enter the Random menu, then turn the volume knob to select one of the following options: <ul style="list-style-type: none"><li>• OFF - Cancels the <b>RDM</b> function.</li><li>• ALL SONGS - Plays all tracks in random order.</li></ul>
<b>CD-R/CD-RW Compatibility</b>	<p>Some CD-Rs and CD-RWs may be incompatible with this unit, depending on media type and recording method. In addition, the following CDs may be incompatible with this unit:</p> <p>CDs exposed to extreme temperatures or direct sunlight for extended periods of time, CDs recorded in which a recording session failed or a re-recording was attempted and, or encrypted or copy-protected CDs which do not conform to the audio CD-DA red book recording standard.</p>



## XDMA7800

### CD Player Operation - MP3/WMA/AAC

#### Playing an MP3/WMA/ AAC Disc

When an MP3/WMA/AAC encoded disc is first inserted, "READING" will appear in the display. Depending on the number of files and folders, this may take several seconds.

#### Folder Access

Press  to select the next folder.  
Press  to select the previous folder.

\*Folder access is only available on discs recorded with more than one folder.

#### Repeat

Press **RPT** to enter the Repeat menu, then turn the **volume knob** to select one of the following options:

- ALL SONGS - Plays all tracks on CD.
- CURRENT SONG - Continuously repeats selected track.
- CURRENT FOLDER - Continuously repeats all files in the folder.

#### Random

Press **RDM** to enter the Random menu, then turn the **volume knob** to select one of the following options:

- OFF - Cancels the **RDM** function.
- ALL SONGS - Plays all tracks in random order.
- CURRENT FOLDER - Plays all tracks in the folder in random order.

**Note:** Random mode is retained in memory when selecting between other modes and when the unit is turned on/off.

#### Intro

Press **INT** to enter the Intro menu, then turn the **volume knob** to select one of the following options:

- OFF - Cancels the **INT** function.
- ALL SONGS - Plays first 10 seconds of each track.
- CURRENT FOLDER - Plays first 10 seconds of each track in folder.

**Note:** Folder repeat, random and intro options only function on MP3/WMA/AAC discs recorded with more than one folder.

# XDMA7800

## CD Player Operation - MP3/WMA/AAC

### Displayed Information

Press **DISPLAY** to select between displayed information such as ID3 tag information and file/folder names.

#### Display layout for MP3/WMA/AAC CD's

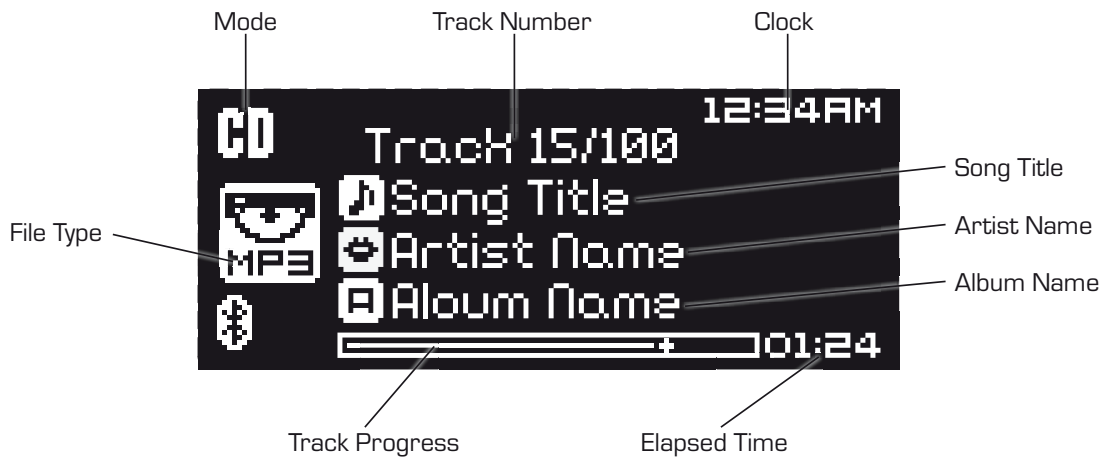

### File/Folder Search

MP3/WMA/AAC CD mode features a file and folder search mode. This search allows navigating through folders to find a specific file for playback.

To begin searching, press **SELECT**. "CD SEARCH" will appear on the top of the display, then a list of the files in the current folder will be displayed. The current folder name will be shown on the top of the list, as seen below.

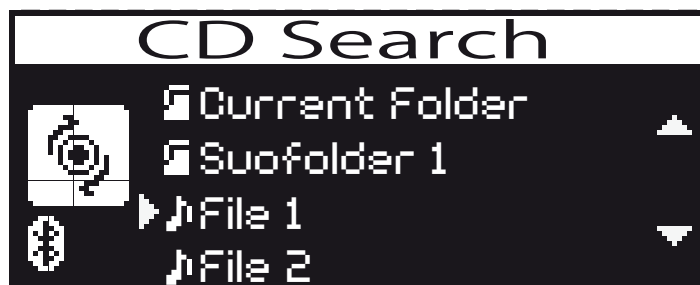



## XDMA7800

# CD Player Operation - MP3/WMA/AAC

## File/Folder Search (continued)

### Search menu navigation

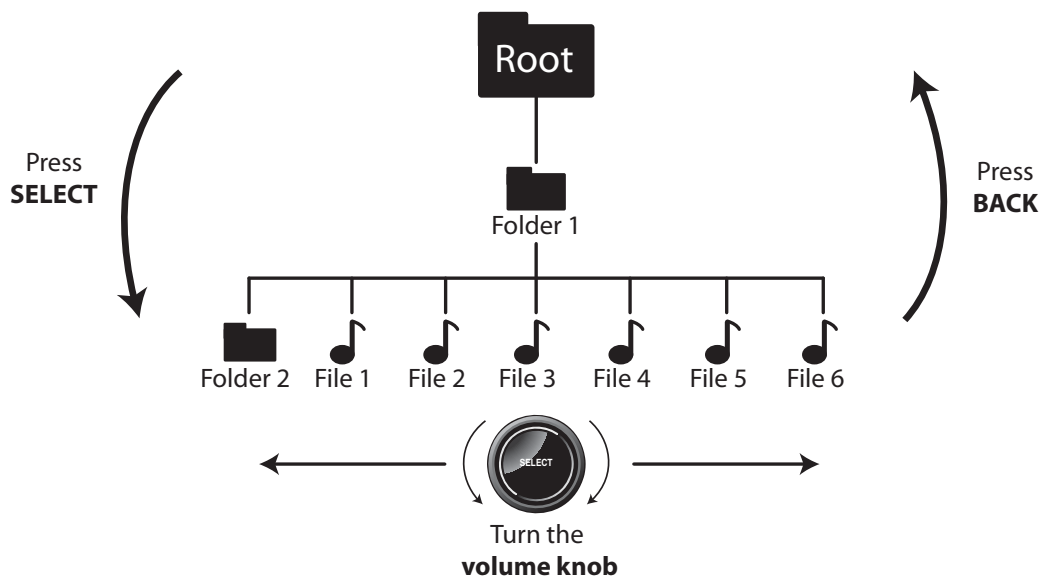

Controls for File/Folder search:

- **Volume knob:** Turn to cycle through the list of folders/files in the current folder.
- **SELECT:** View the contents of the highlighted folder, or to play the highlighted file.
- **BACK:** Return to the previous folder, or to exit out of the menu while the root folder is being viewed.

## XDMA7800

# CD Player Operation - MP3/WMA/AAC

## File/Folder Compatibility and Support

<b>Compatible File Types</b>	<ul style="list-style-type: none"><li>• CD-ROM (ISO), CD-R, CD-RW</li><li>• CD-DA (digital audio)</li><li>• MP3 data (.mp3)</li><li>• WMA data (.wma)</li><li>• AAC data (.m4a)</li></ul>
<b>Incompatible File Types</b>	<ul style="list-style-type: none"><li>• DRM protected files</li><li>• WMA lossless</li><li>• Apple lossless</li><li>• WMA Pro</li><li>• MP3 Pro</li><li>• MP3 playlists</li><li>• WAV lossless</li></ul>
<b>Recording Format Compatibility</b>	<ul style="list-style-type: none"><li>• ISO9660 level 1 &amp; level 2</li><li>• Yellow book MODE 1 &amp; MODE 2 FORM 1</li><li>• Multi session</li></ul>
<b>Sampling Frequency Rate Compatibility</b>	<ul style="list-style-type: none"><li>• MP3: 8kHz - 48kHz</li><li>• WMA: 32kHz - 48kHz</li><li>• AAC: 8kHz - 48kHz</li></ul>
<b>Transfer Bit Rate Compatibility</b>	<ul style="list-style-type: none"><li>• MP3: 32kbps - 320kbps</li><li>• WMA: 32kbps - 192kbps</li><li>• AAC: 48kbps - 288kbps</li></ul>
<b>Character Support</b>	<ul style="list-style-type: none"><li>• Song Title: 30 characters</li><li>• Artist Name: 30 characters</li><li>• Album Name: 30 characters</li><li>• File Name: 32 characters</li><li>• Folder Name: 32 characters</li></ul>
<b>ID3 Tag Support</b>	<ul style="list-style-type: none"><li>• MP3 Tags: Version 1.0 - 2.4</li><li>• WMA Tags</li></ul>
<b>File/Folder Limit</b>	<ul style="list-style-type: none"><li>• Maximum folders and files: 256</li><li>• Maximum folder levels: 8</li></ul>

# XDMA7800

## Operation of iPod/iPhone

### Connecting an iPod/iPhone Device

#### USB Connection



Using the "dock connector to USB" sync cable (provided with the iPod/iPhone device), plug the USB cable into one of the XDMA7800's two USB ports. Once connected, playback will begin automatically.

You may connect the iPod/iPhone device to the front USB port, rear USB port, or to both ports. A USB extension cable is included for better rear USB port access.

### Controlling a Device: Full Control

When the control of iPod/iPhone feature is set to "FULL" in the iPod Menu, use the following functions to control the device:

#### Song Select

Press **▶▶** to skip to the beginning of the next song.  
Press **◀◀** to return to the beginning of the current song.  
Pressing **◀◀** again skips to the beginning of the previous song.

#### Fast Forward and Reverse

Press and hold **▶▶** or **◀◀** to fast forward or reverse a song.

#### Pause

Press **▶/||** to temporarily stop playback.  
Press **▶/||** again to resume playback.

#### Repeat

Press **RPT** to enter the Repeat menu, then turn the **volume knob** to select one of the following options:

- ALL SONGS - Repeats all tracks.
- CURRENT SONG - Repeats selected track.

#### Random

Press **RDM** to enter the Random menu, then turn the **volume knob** to select one of the following options:

- OFF - Cancels the **RDM** function.
- ALL SONGS - Plays all tracks in random order.
- CURRENT ALBUM - Plays all tracks in the selected album in random order.

#### Intro

Press **INT** to enter the Intro menu, then turn the **volume knob** to select one of the following options:

- OFF - Cancels the **INT** function.
- ON - Plays first 10 seconds of each track.

# XDMA7800

## Operation of iPod/iPhone

### Controlling a Device: Full Control - Music Search

The XDMA7800 features a powerful music search that simplifies the searching process. Follow the steps below to find the desired song:

**Begin Searching** | Press **SELECT** to begin the search. The main search menu will appear.

**Select a Category** | Turn the **volume knob** to select between **artist, album, song, playlist, podcast, audiobook and genre**. Press **SELECT** to select the desired search category. Some categories have subcategories to navigate through. See the table below for details.

Search Category	Menu Navigation
<b>Artist</b>	Menu → Artists → Albums → Songs
<b>Album</b>	Menu → Albums → Songs
<b>Song</b>	Menu → Songs
<b>Playlist</b>	Menu → Playlists → Songs
<b>Audiobook</b>	Menu → Audiobooks
<b>Podcast</b>	Menu → Podcasts
<b>Genre</b>	Menu → Genre → Genres List → Artists → Albums → Songs

**Step Backwards** | Press **BACK** to return to the previous menu, or exit the search menu when the main menu is shown.

**Playing a Song** | Navigate to the desired song/podcast/audiobook and press **SELECT** to begin playback.  
**Note:** If a specific category is selected, the iPod/iPhone device playback will be limited to that category until another category is selected in the search menu.

## Device Compatibility

- Made for**
- iPod nano (5th generation)
  - iPod touch (2nd generation)
  - iPod nano (4th generation)
  - iPod classic
  - iPod touch (1st generation)
  - iPod nano (3rd generation)
  - iPod nano (2nd generation)
  - iPod with video
  - iPhone 4
  - iPhone 3GS
  - iPhone 3G
  - iPhone

**Note:** See page 13 for iPod and iPhone device compatibility with iTunes Tagging.

# XDMA7800

## Operation of iPod/iPhone

### Controlling a Device: Manual Control

When the control of iPod/iPhone feature is set to "MANUAL" in the iPod Menu, use the following functions to control the device:

<b>Manual Control for iPod</b>	When "MANUAL" control is selected from the iPod Menu, the iPod or iPhone device can be controlled directly from the device's interface. All functions except for volume can be used from the iPod or iPhone device.
<b>Basic Head Unit Control</b>	In addition to manual control of the iPod/iPhone device, the following basic functions are still active:
<b>Song Select</b>	Press ►► to skip to the beginning of the next song. Press ◀◀ to return to the beginning of the current song. Pressing ◀◀ again skips to the beginning of the previous song.
<b>Pause</b>	Press ►/   to temporarily stop playback. Press ►/   again to resume playback.
<b>Volume</b>	When playing an iPod device, the volume is adjustable using the volume controls on inside panel.

### Displaying Information

Press the **DISPLAY** button to change between different types of information such as ID3 song information and the clock. Below is the default display for iPod mode.

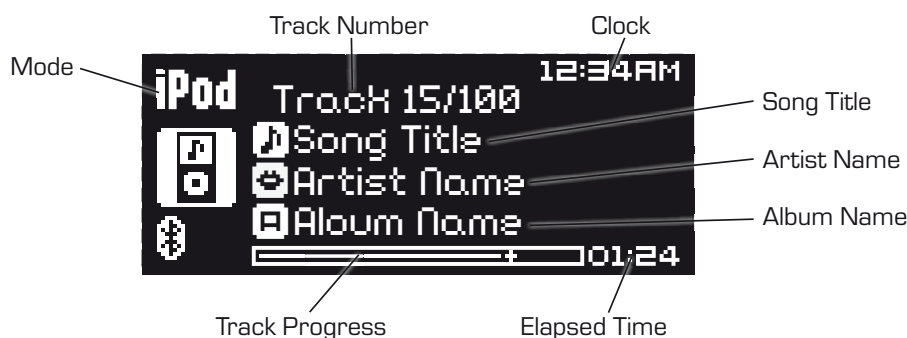

### Character Support

Only alphanumeric characters can be displayed (ASCII type).

- "NO SUPPORT" will be displayed if the file contains characters that can not be displayed.
- "NO FILE" will be displayed if there are no songs in the selected playlist.



Maximum character display information

- \*Song title - 32 character maximum
- \*Artist name - 32 character maximum
- \*Album name - 32 character maximum

\*Song Title, Artist Name and Album name will only be displayed if included with the file.

# XDMA7800

## USB/SD Card Operation

<b>Connect a USB Device (sold separately)</b>	To play MP3/WMA/AAC files from most mass storage devices, connect a device to one of the XDMA7800's two USB ports (front or rear).
<b>Connect an SD Card (sold separately)</b>	To play MP3/WMA/AAC files from an SD Card, insert an SD card into the XDMA7800's SD card slot, located behind the front panel. Insert the SD card with the label facing to the left, and press the card until it clicks into place. Remove the SD card by pressing in until it clicks, then pull to remove.
<b>Playing Music</b>	When a USB or SD card device is first connected, playback will begin momentarily. Depending on the number of files and folders, it may take several seconds for the device to begin playing. If no valid MP3/WMA/AAC files are detected, "NO FILE" will be displayed and the last mode will be resumed.
<b>Track Select</b>	Press <b>TRACK</b> ►► to skip to the beginning of the next track. Press <b>TRACK</b> ◄◄ to return to the beginning of the current track. Pressing <b>TRACK</b> ◄◄ again skips to the beginning of the previous track.
<b>Fast Forward and Reverse</b>	Press and hold <b>TRACK</b> ►► or <b>TRACK</b> ◄◄ to fast forward or reverse a track.
<b>Pause</b>	Press ►/   to temporarily stop USB playback. Press ►/   again to resume playback.
<b>Folder Access</b>	Press  to select the previous folder. Press  to select the next folder.  <b>Note:</b> Folder access is only available on USB/SD Card devices with more than one folder.
<b>Repeat</b>	Press <b>RPT</b> to enter the Repeat menu, then turn the <b>volume knob</b> to select one of the following options: <ul style="list-style-type: none"><li>• ALL SONGS - Plays all tracks on the USB/SD Card device.</li><li>• CURRENT SONG - Continuously repeats selected track.</li><li>• CURRENT FOLDER - Continuously repeats all files in selected folder.</li></ul>
<b>Random</b>	Press <b>RDM</b> to enter the Random menu, then turn the <b>volume knob</b> to select one of the following options: <ul style="list-style-type: none"><li>• OFF - Cancels the <b>RDM</b> function.</li><li>• ALL SONGS - Plays all tracks in random order.</li><li>• CURRENT FOLDER - Plays all tracks in folder in random order.</li></ul> <b>Note:</b> Random mode is retained in memory when selecting between other modes and when the unit is turned on/off.
<b>Intro</b>	Press <b>INT</b> to enter the Intro menu, then turn the <b>volume knob</b> to select one of the following options: <ul style="list-style-type: none"><li>• OFF - Cancels the <b>INT</b> function.</li><li>• ALL SONGS - Plays first 10 seconds of each track.</li><li>• CURRENT FOLDER - Plays first 10 seconds of each track in folder.</li></ul>

# XDMA7800

## USB / SD Card Operation

### File and Folder Search

USB and SD card modes features a file and folder search mode. This search allows navigating through folders to find a specific file for playback.

Press **SELECT** to begin searching. A list of the files in the current folder will be displayed. The current folder name will be shown on the top of the list, as seen below.

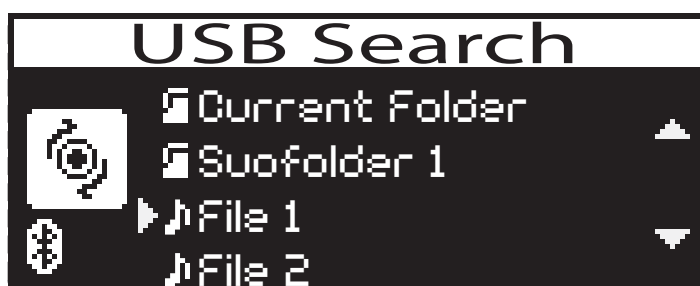

#### Search menu navigation

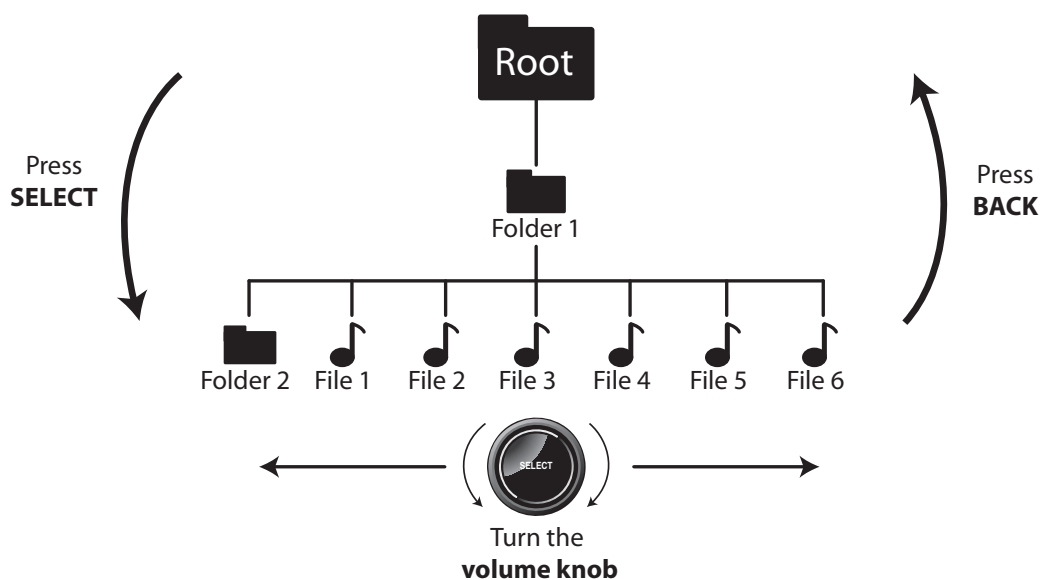

Controls for File/Folder search:

- **Volume knob:** Turn to cycle through the list of folders/files in the current folder.
- **SELECT:** View the contents of the highlighted folder, or to play the highlighted file.
- **BACK:** Return to the previous folder, or to exit out of the menu while the root folder is being viewed.

# XDMA7800

## USB / SD Card Operation

### Displayed Information

Press **DISPLAY** to select between displayed information such as ID3 tag information and file/folder names.

#### Display layout for MP3/WMA/AAC USB and SD Card Devices

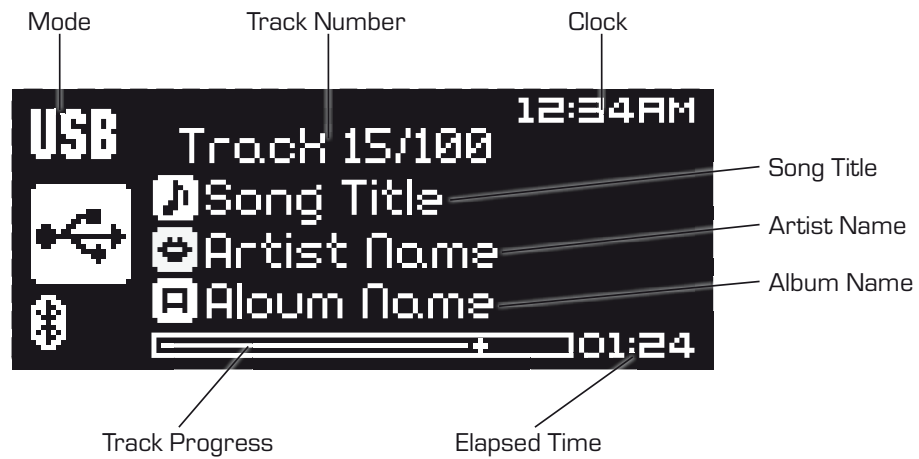



# XDMA7800

## USB / SD Card Operation

### File/Folder Compatibility and Support

<b>Compatible File Types</b>	<ul style="list-style-type: none"><li>• CD-ROM (ISO), CD-R, CD-RW</li><li>• CD-DA (digital audio)</li><li>• MP3 data (.mp3)</li><li>• WMA data (.wma)</li><li>• AAC data (.m4a)</li><li>• WAV lossless</li></ul>
<b>Incompatible File Types</b>	<ul style="list-style-type: none"><li>• DRM protected files</li><li>• WMA lossless</li><li>• Apple lossless</li><li>• WMA Pro</li><li>• MP3 Pro</li><li>• MP3 playlists</li></ul>
<b>Recording Format Compatibility</b>	<ul style="list-style-type: none"><li>• ISO9660 level 1 &amp; level 2</li><li>• Yellow book MODE 1 &amp; MODE 2 FORM 1</li><li>• Multi session</li></ul>
<b>Sampling Frequency Rate Compatibility</b>	<ul style="list-style-type: none"><li>• MP3: 8kHz - 48kHz</li><li>• WMA: 32kHz - 48kHz</li><li>• AAC: 8kHz - 48kHz</li></ul>
<b>Transfer Bit Rate Compatibility</b>	<ul style="list-style-type: none"><li>• MP3: 32kbps - 320kbps</li><li>• WMA: 32kbps - 192kbps</li><li>• AAC: 48kbps - 288kbps</li></ul>
<b>Character Support</b>	<ul style="list-style-type: none"><li>• Song Title: 30 characters</li><li>• Artist Name: 30 characters</li><li>• Album Name: 30 characters</li><li>• File Name: 32 characters</li><li>• Folder Name: 32 characters</li></ul>
<b>ID3 Tag Support</b>	<ul style="list-style-type: none"><li>• MP3 Tags: Version 1.0 - 2.4</li><li>• WMA Tags</li></ul>
<b>File/Folder Limit</b>	<ul style="list-style-type: none"><li>• Maximum number of files: 65535</li><li>• Maximum number of folders: 65535 (plus the root folder)</li><li>• Maximum number of files in each folder: 65535</li><li>• Maximum folder levels: 7</li></ul> <p><b>Note:</b> For devices with more than the maximum number of files/folders, some files will be ingnored and may not function properly.</p>
<b>USB/SD File System</b>	<ul style="list-style-type: none"><li>• FAT/FAT32 file system supported.</li><li>• HFS/NTFS/EXT2/EXT3 not supported.</li></ul>
<b>SD Card Capacity</b>	16GB or less supported.

# XDMA7800

## Bluetooth® Operation

### Pairing a Device

#### Preparation

Before you can use a Bluetooth device, it must be paired and connected. Make sure that Bluetooth is activated on your device before you begin the pairing process.

#### Pairing a New Device

The XDMA7800 broadcasts the pairing signal constantly when no devices are currently connected. Complete the pairing sequence from your Bluetooth device. Refer to the owner's manual for your device for more details.

**The device name is "XDMA7800"  
The Bluetooth passcode "1234"**



**Note:** The XDMA7800 can be in any mode of operation when pairing is performed.

#### Pairing Additional Devices

If a device is currently connected, press and hold  to disconnect the current device before a new device can be paired. Then begin the pairing sequence from the new Bluetooth device.

### Connecting a Paired Device

Most Bluetooth devices support the auto-connect feature, and will connect automatically if the device is in range when the XDMA7800 is powered-on. If your device was previously paired but does not connect, use these instructions below.

- If your most recently connected Bluetooth device becomes disconnected or does not reconnect, press  from Bluetooth mode to reconnect your mobile device.
- To connect a previously paired device that was not recently connected:
  - 1) If applicable, press and hold  to disconnect any connected mobile devices.
  - 2) From Bluetooth mode, press **SELECT**. "Paired Devices" will appear on the LCD.
  - 3) Turn the volume knob to cycle through the list of devices 1 through 10.
  - 4) Press **SELECT** or  to connect to the desired device. It must be in range to connect.

**Note:** If the **Auto Connect** setup menu setting is set to **OFF**, you must press  to connect you device after pairing, and each time the XDMA7800 is powered-on.

### Disconnecting a Device



Press and hold  for 3 seconds to disconnect a connected device. The device will remain paired and appear in the PAIRED DEVICES menu, but not be connected.

# XDMA7800

## Bluetooth® Operation



### Making a Phone Call

#### Manual Dialing

- Press  once. "Enter Number" will be shown, then an " " will appear on the display.
- Using the remote control, enter the phone number using the 0-9 buttons. Press  on the remote control or XDMA7800 front panel to begin dialing.

**Note:** Placing a phone call from your cell phone will also use the Bluetooth function of the XDMA7800.

#### Recent Calls List

- Press  twice from Bluetooth mode to view the 10 most recent phone calls that were dialed, received or missed while connected to the XDMA7800.
- Turn the volume knob to cycle through the recent phone numbers. Press SELECT or  to dial the phone number.





#### Redialing the last number

To redial the last phone number, press  three times from Bluetooth mode. Dialing will begin automatically.

#### Phonebook Menu \*

The XDMA7800 supports the PBAP Bluetooth profile to temporarily download the phonebook of the cell phone.

**Note:** The contents of the phonebook are deleted each time a cell phone is disconnected, and not permanently saved.



- Press **SELECT** from Bluetooth mode, with a compatible cell phone connected. "Phonebook Contacts" will appear on the LCD, followed by names from your downloaded phonebook.
- Turn the **volume knob** left/right to cycle through the names in the phonebook. Only names with valid phone numbers are displayed in the list. Press / to skip quickly through the contact list.
- Press **SELECT** when the desired name is displayed. A list of CELL, HOME, WORK, and OTHER phone number types will be shown.
- Turn the **volume knob** or press / to cycle between the phone number types.
- Press **SELECT** or  when a phone number is displayed to begin dialing the number.

\*The Bluetooth phone must support the PBAP Bluetooth profile to enable the phonebook feature. Check the owner's manual of your phone for details.





# XDMA7800

## Bluetooth® Operation

### Receiving and Ending Phone Calls

<b>Receiving a Phone Call</b>	<p>Incoming phone calls will automatically appear on the display and a ring tone will be heard.</p> <p><b>Note:</b> The volume of the ring tone depends on the volume level of the XDMA7800. The incoming ring tone may not be heard if the volume is set to a low level or mute is activated.</p> <ul style="list-style-type: none"><li>• Press  to receive the incoming phone call.</li><li>• Press  to refuse the incoming phone call.</li></ul> <p><b>Note:</b> If <b>Auto Answer</b> is set to <b>ON</b> in the setup menu, all phone calls will be received automatically.</p>
<b>Ending a Phone Call</b>	<p>During an active phone call, press  to end a phone call. If the phone call was received when listening to music in another mode, the XDMA7800 will resume the previous mode.</p>

### During a Phone Call

<b>Volume</b>	<p>Turn the <b>volume knob</b> to adjust the volume level during a phone call. Bluetooth mode has a separate volume level from the main volume of other modes. The XDMA7800 will remember the volume level in Bluetooth mode and always return to the last volume level for each phone call.</p>
<b>Microphone Mute</b>	<p>Press <b>MUTE</b> during a phone call to turn the XDMA7800's external microphone off. Press <b>MUTE</b> again to resume microphone operation.</p>
<b>Audio Transfer</b>	<p>Press <b>DISPLAY</b> during a phone call to transfer the call from the XDMA7800 to the cell phone. Press <b>DISPLAY</b> again to toggle the audio back to the XDMA7800.</p>
<b>Call Waiting</b>	<p>During a phone call, if there is a second incoming call, press  to place the first call on hold and switch to the second phone call. Press  again to switch back to the first call.</p>
<b>Call Hold</b>	<p>During a phone call, when there are no additional incoming calls, press  to place the call on hold. Press  again to resume the phone call.</p> <p><b>Note:</b> Audio transfer, call waiting and call hold must be supported by the mobile phone and service provider to function properly.</p>

# XDMA7800

---

## Bluetooth® Operation





### Streaming Audio Operation

The XDMA7800 supports A2DP (advanced audio distribution profile) wireless streaming audio from your Bluetooth mobile device directly to your head unit. You can also control your music from the front panel of the head unit using AVRCP (audio video remote control profile).

**Notes:**

- To stream music to your head unit, your mobile device must support the A2DP and AVRCP Bluetooth profiles. Check the owner's manual of your mobile device for details.
- Streaming audio must be enabled from your mobile device. This option will vary depending on the device. Some devices allow streaming audio to be disabled.

After pairing, connecting and enabling streaming audio from a compatible mobile device, begin playing music using the music player on your mobile device. Once the music is playing, the following functions can be used to control the music:

- The  button will skip to the next available audio track.
- The  button will skip to the previous audio track.
- The  button will toggle between play and pause during playback.
- The  button will stop the audio playback.

**Note:** Some Bluetooth devices may not fully support these commands.

### Bluetooth Reset

Resetting the Bluetooth module will remove the list of paired phones and delete the list of recent calls from memory.

To reset Bluetooth, perform the following steps:

- 1) Press **SOURCE** until the head unit is in Bluetooth mode.
- 2) Press and hold **MENU** for 3 seconds to reset the Bluetooth settings back to the factory default.

**Compatibility Note:**

Due to the differences in Bluetooth technology, some mobile devices may be incompatible, function improperly or may not support all features when used with the XDMA7800.

## XDMA7800

---

### Limited One Year Warranty

This warranty gives you specific legal rights. You may also have other rights which vary from state to state.

Dual Electronics Corp. warrants this product to the original purchaser to be free from defects in material and workmanship for a period of one year from the date of the original purchase.

Dual Electronics Corp. agrees, at our option, during the warranty period, to repair any defect in material or workmanship or to furnish an equal new, renewed or comparable product (whichever is deemed necessary) in exchange without charges, subject to verification of the defect or malfunction and proof of the date of purchase. Subsequent replacement products are warranted for the balance of the original warranty period.

**Who is covered?** This warranty is extended to the original retail purchaser for products purchased from an authorized Dual dealer and used in the U.S.A.

**What is covered?** This warranty covers all defects in material and workmanship in this product. The following are not covered: software, installation/removal costs, damage resulting from accident, misuse, abuse, neglect, product modification, improper installation, incorrect line voltage, unauthorized repair or failure to follow instructions supplied with the product, or damage occurring during return shipment of the product. Specific license conditions and copyright notices for the software can be found via [axxera.dualav.com](http://axxera.dualav.com).

#### What to do?

1. Before you call for service, check the troubleshooting guide in your owner's manual. A slight adjustment of any custom controls may save you a service call.
2. If you require service during the warranty period, you must carefully pack the product (preferably in the original package) and ship it by prepaid transportation with a copy of the original receipt from the retailer to an authorized service center.
3. Please describe your problem in writing and include your name, a return UPS shipping address (P.O. Box not acceptable), and a daytime phone number with your shipment.
4. For more information and for the location of the nearest authorized service center please contact us by one of the following methods:
  - Call us toll free at 1 866 382 5476
  - E mail us at [cs@dualav.com](mailto:cs@dualav.com)

**Exclusion of Certain Damages:** This warranty is exclusive and in lieu of any and all other warranties, expressed or implied, including without limitation the implied warranties of merchantability and fitness for a particular purpose and any obligation, liability, right, claim or remedy in contract or tort, whether or not arising from the company's negligence, actual or imputed. No person or representative is authorized to assume for the company any other liability in connection with the sale of this product. In no event shall the company be liable for indirect, incidental or consequential damages.

# XDMA7800

## Troubleshooting - General

Problem	Cause	Action
<b>Unit will not turn on (no power)</b>	Yellow wire not connected or incorrect voltage Red wire not connected or incorrect voltage	Check connections for proper voltage (11-16VDC)
	Black wire not connected	Check connection to ground
	Fuse blown	Replace fuse
<b>Unit has power (but no sound)</b>	Speaker wires not connected	Check connections at speakers
	One or more speaker wires touching each other or touching chassis ground	Insulate all bare speaker wires from each other and chassis ground
<b>Unit blows fuses</b>	Yellow or red wire touching chassis ground	Check for pinched wire
	Speaker wires touching chassis ground	Check for pinched wire
	Incorrect fuse rating	Use fuse with correct rating
<b>Excessive Skipping</b>	Unit is not mounted correctly or backstrap is not secure	Check mounting sleeve and backstrap support
	Physical defect in CD, CD-R/RW disc	Check media for scratches
<b>ERROR-01 appears on display</b>	Disc read error	Press <b>EJECT</b> or <b>RESET</b>
<b>ERROR-02 appears on display</b>	Focus error or disc is in upside down	Press <b>EJECT</b> or <b>RESET</b>
<b>CD will not eject</b>	CD mechanism error	Hold <b>EJECT</b> for 3 seconds to force eject the CD
<b>PROTECT appears on display</b>	The WMA file is copy-protected by DRM (Digital Rights Management)	Write disc using WMA files that are not copy-protected
<b>NO FILE appears on display</b>	Selected file is not available in direct or alphanumeric search modes	Repeat search using valid parameters
<b>INVALID appears on display</b>	The file format is incompatible	Write disc using valid audio files with .mp3, .wma or .m4a file extensions
<b>NO SUPPORT appears on display</b>	An invalid ID3 tag version is present	Version 1.0 to 2.4 ID3 tags are supported.

# XDMA7800

## Specifications

<b>FM Tuner</b>	Tuning range: <b>87.5MHz - 107.9MHz</b> Usable sensitivity: <b>8.5dBf</b> 50dB quieting sensitivity: <b>10dBf</b> Stereo separation @ 1kHz: <b>40dB</b> Frequency response: <b>30Hz - 13kHz</b>
<b>AM Tuner</b>	Tuning range: <b>530kHz - 1710kHz</b> Usable sensitivity: <b>22uV</b> Frequency response: <b>30Hz - 2.2kHz</b>
<b>General</b>	Speaker output impedance: <b>4 to 8 ohms</b> Line output voltage: <b>2 Volts RMS</b> Dimensions: <b>7" x 7" x 2" (178 x 178 x 51 mm)</b>
<b>USB/SD Card</b>	File system: <b>FAT, FAT32</b> File extensions support: <b>.mp3, .wma, .m4a</b> SD Card maximum device capacity: <b>16GB</b>
<b>Bluetooth® Profiles</b>	<b>HFP</b> (hands-free profile) <b>A2DP</b> (advanced audio distribution profile) <b>AVRCP</b> (audio video remote control profile) <b>PBAP</b> (phone book access profile)

Design and specifications subject to change without notice.



CEA 2006 Power Standard Specifications  
(reference: 14.4VDC +/- 0.2V, 20Hz - 20kHz)

Power Output: 18 Watts RMS x 4 channels at 4 ohms and  $\leq 1\%$  THD+N  
Signal to Noise Ratio: 80dBA (reference: 1 watt into 4 ohms)



# XDMA7800

---

## FCC Compliance

This device complies with Part 15 of the FCC Rules. Operation is subject to the following two conditions:

(1) this device may not cause harmful interference, and

(2) this device must accept any interference received, including interference that may cause undesired operation.

**Warning:** Changes or modifications to this unit not expressly approved by the party responsible for compliance could void the user's authority to operate the equipment.

**Note:** This equipment has been tested and found to comply with the limits for a Class B digital device, pursuant to Part 15 of the FCC Rules. These limits are designed to provide reasonable protection against harmful interference in a residential installation. This equipment generates, uses and can radiate radio frequency energy and, if not installed and used in accordance with the instructions, may cause harmful interference to radio communications. However, there is no guarantee that interference will not occur in a particular installation. If this equipment does cause harmful interference to radio or television reception, which can be determined by turning the equipment off and on, the user is encouraged to try to correct the interference by one or more of the following measures:

- Reorient or relocate the receiving antenna.
- Increase the separation between the equipment and receiver.
- Connect the equipment into an outlet on a circuit different from that to which the receiver is connected.
- Consult the dealer or an experienced radio/TV technician for help.

# **XDMA7800**

---

## **Notes**

# **XDMA7800**

---

## **Notes**



Dual Electronics Corp.  
Toll Free: 1-866-382-5476  
[axxera.dualav.com](http://axxera.dualav.com)

©2011 Dual Electronics Corp. All rights reserved.

iPhone, iPod, iPod classic, iPod nano, and iPod touch are trademarks of Apple Inc., registered in the U.S. and other countries.

"Made for iPod" and "Made for iPhone" mean that an electronic accessory has been designed to connect specifically to iPod or iPhone, respectively, and has been certified by the developer to meet Apple performance standards. Apple is not responsible for the operation of this device or its compliance with safety and regulatory standards. Please note that the use of this accessory with iPod or iPhone may affect wireless performance.

The Bluetooth® word mark and logos are owned by the Bluetooth SIG, Inc. and any use of such marks by Namsung is under license.

HD Radio™, HD Radio Ready™, and the HD Radio Ready logo are proprietary trademarks of iBiquity Digital Corporation.

The SD logo is a trademark of the SD Card Association.

Other trademarks and trade names are those of their respective owners.

NSA0411-V01